

Commercial & Residential Locks

900 Series Exploded View

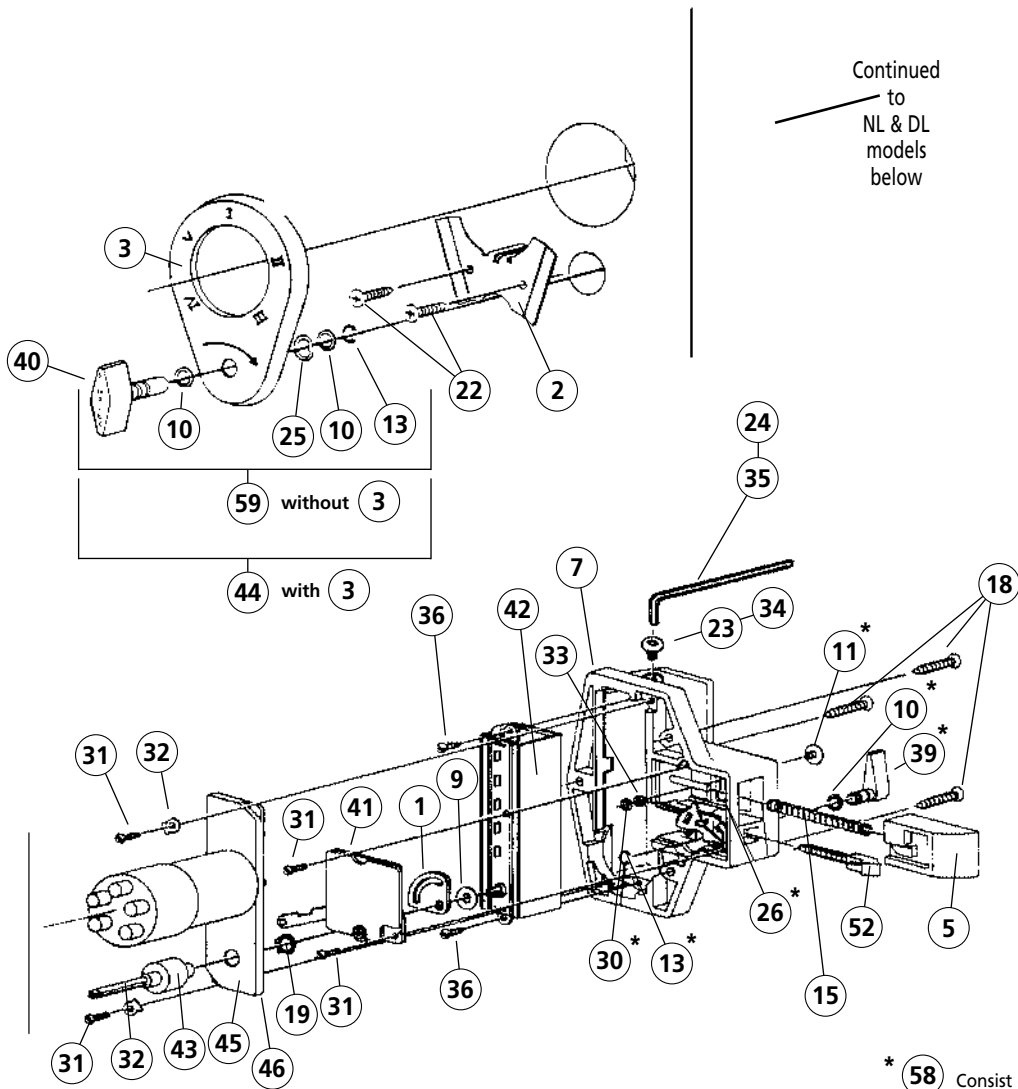
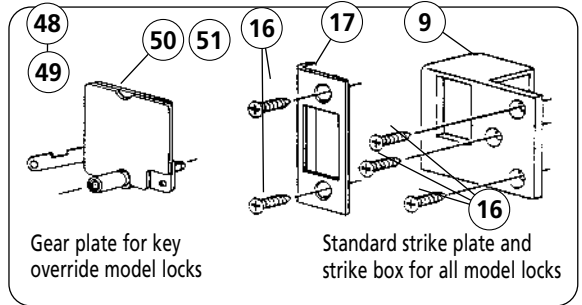
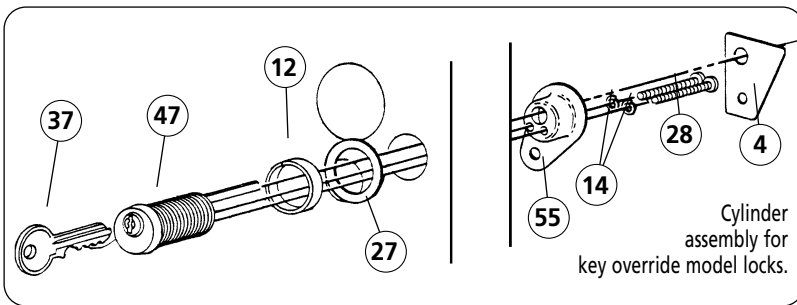

* 58 Consist of 11, 26, 30
 * 60 Consist of 10, 13, 39

Commercial & Residential Locks

900 Series Exploded View & Auxiliary Lock

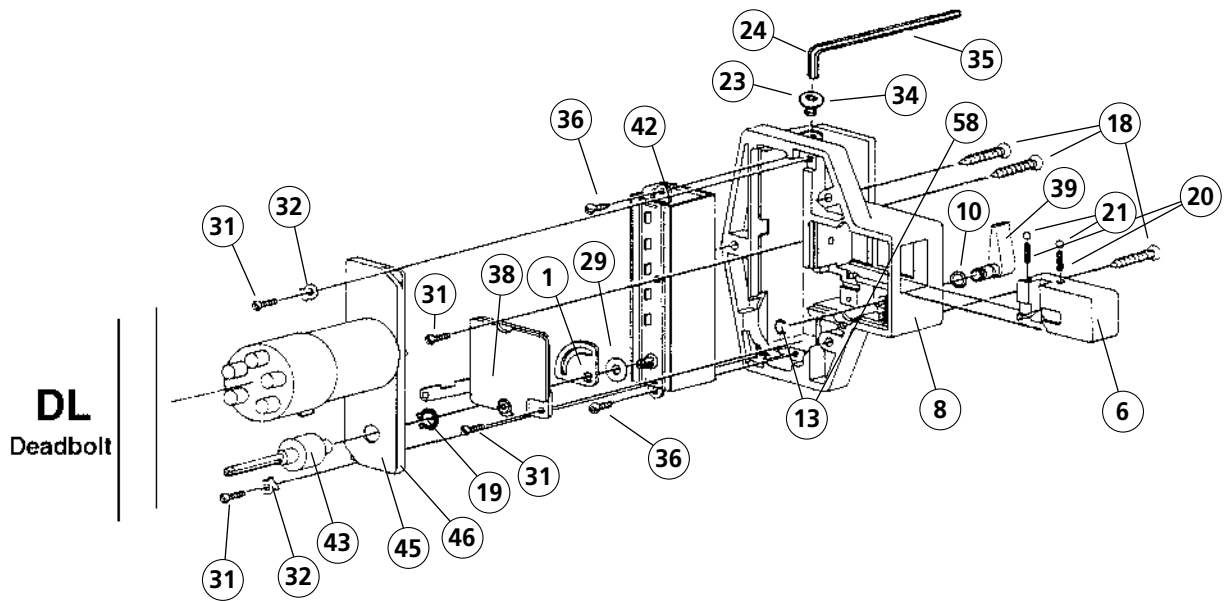

ACCESSORIES

Face Plate Shield

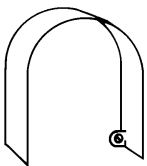

Part #805

Adapter Kit

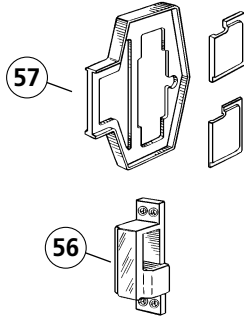

Part #800/801

Surface Mounted Strike Box



Part #74464

OPTIONS

Inside Lever Handle

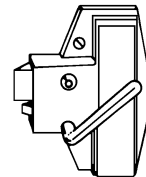

Part #74437

Panic Bar Release Kit

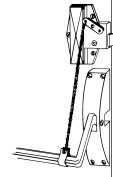

Part #74438











Product # (Old #)	Description
800-04-41 (74464/74468)	Adapter Kit for doors with metal frames.
800-26D-41 (74464/74468)	Includes riser plates and surface strike
805-26D-41 (24081-000-01)	Face plate shield (not for key override)
54266-1-11 (54266-1)	Master keys for key override models
54266-2-11 (54266-2)	Cut Keys Service Keys for key override models
54266	Blank Keys

Commercial & Residential Locks

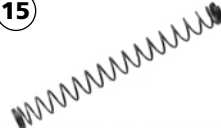
900 Series Replacement Parts

Exploded View Drawing
on pages 45-46





















	<p>Sector Cam (For Combination Chamber Control Shaft) 24046-000-01</p>
	<p>Holding Bracket (For attaching face plate to outside of door) 24063-000-01</p>
	<p>Face Plate 24064-04-01 24064-26D-01</p>
	<p>Clip Flange Cover 24108-04-01 24108-26D-01</p>
	<p>Latch Bolt (For Models 9170000, 9190000, 9350000, 9380000, 9290000, NL) 34011-04-01 34011-26D-01</p>
	<p>Deadbolt (For Models 9020000, 9040000, 9060000, 9100000, DL) 34012-04-01 34012-026D-01</p>
	<p>Lock Housing (For Models 9170000, 9190000, 9350000 & 9380000, NL) 34021-04-01 34021-26D-01</p>
	<p>Lock Housing (For Models 9020000, 9040000, 9060000 & 9100000, DL) 34022-04-01 34022-26D-01</p>
	<p>Mortise Strike Box 34023-04-01 34023-26D-01</p>
	<p>Nylon Washer, Spacer (For Face Plate and Inside Knob) 34037-000-05</p>

	<p>Latch Holdback Button (For Models 9170000, 9190000, 9350000, 9380000, NL) 44036-04-01 44036-26D-01</p>
	<p>Space Collar (For Models 9060000 & 9350000) 44112-04-01 44112-26D-01</p>
	<p>Knob Retainer Ring (For Face Plate and Inside Knob) 54011-000-05</p>
	<p>Lockwasher (For Key Override Assembly) 54029-000-10</p>
	<p>Latch Return Spring (For Models 9170000, 9190000, 9350000, 9380000, 9290000, NL) 54050-000-10</p>
	<p>Strike Mounting Screw (#10 x 1") 54052-04-10 54052-26D-10</p>
	<p>Flat Strike 54053-04-01 54053-26D-01</p>
	<p>Housing Mounting Screw (#10 x 1½") 54061-04-10 54061-26D-10</p>
	<p>Clutch Retainer Ring 54070-000-10</p>
	<p>Spring (For Deadbolt Ball Bearings) 54074-000-10</p>

Commercial & Residential Locks

900 Series Replacement Parts













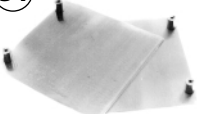

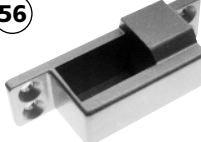

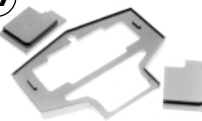
Exploded View Drawing
on pages 45-46

<p>21</p> 	<p>Ball Bearings (For Deadbolt) 54075-000-10</p>	<p>31</p> 	<p>Screw Panhead (#4 - 40 x 5/16") (For Securing Gear Plate) 54117-000-10</p>
<p>22</p> 	<p>Holding Bracket Screw (#7 x 1/2" Sheet Metal) 54077-000-10</p>	<p>32</p> 	<p>Washer (For Mounting Center Plate) 54120-000-10</p>
<p>23</p> 	<p>Allen Head Button Screw (#10 x 32) 54082-04-01 54082-26D-01</p>	<p>33</p> 	<p>Washer (For Latch Holdback Assembly) 54121-000-10</p>
<p>24</p> 	<p>Allen Wrench (1/8") 54083-000-01</p>	<p>34</p> 	<p>Tamper Proof Access Screw (For Combination Change) 54133-04-01 54133-26D-01</p>
<p>25</p> 	<p>Shakeproof Spring Washer (For Face Plate Assembly) 54084-000-10</p>	<p>35</p> 	<p>Tamper Proof Allen Wrench (For Removing Tamper Access Screw) 54134-000-01</p>
<p>26</p> 	<p>Latch Button Spring (For Latch Holdback Assembly) 54096-000-10</p>	<p>36</p> 	<p>Round Head Sheet Metal Screw (#5 x 5/16") (For Securing Combination Chamber) 54144-000-10</p>
<p>27</p> 	<p>Flange Washer (For Key Override Cylinder) 54097-04-01 54097-26D-01</p>	<p>37</p> 	<p>Key Blank (For Key Override Cylinder) (See page 34 for Cut Keys) 54266</p>
<p>28</p> 	<p>Screw (For Securing Key Override Cylinder) 54099-000-10</p>	<p>38</p> 	<p>Gear Plate Assembly* (For locks without key bypass for Models 9020000, 9040000, DL) 74042-2-000-01</p>
<p>29</p> 	<p>Washer, Shim (For Combination Chamber) 54109-000-10</p>	<p>39</p> 	<p>Inside Knob (Without Hardware) 74057-04-01 74057-26D-01</p>
<p>30</p> 	<p>Retainer Clip, E-Ring (For Latch Holdback Assembly) 54115-000-10</p>	<p>40</p> 	<p>Outside Knob (Without Hardware) 74068-04-01 74068-26D-01</p>

Commercial & Residential Locks

900 Series Replacement Parts

Exploded View Drawing
on pages 45-46

	<p>41</p> <p>Gear Plate Assembly (For locks without key bypass (For Models 9170000, 9190000, NL))</p> <p>74071-000-01</p>		<p>53</p> <p>Drill jig "C" clamp (For wood doors) (Not Shown on Exploded View)</p> <p>74300-000-01</p>
	<p>42</p> <p>Combination Chamber (M-55) Dimensions: 7/8" x 1 5/16" x 3 7/8" (22 mm x 24 mm x 98 mm) Includes: 54109, 24046</p> <p>74080-000-01</p>		<p>54</p> <p>Metal Template (Not Shown on Exploded View)</p> <p>74301-000-01</p>
	<p>43</p> <p>Ball bearing Clutch Assembly (For connecting outside turn knob) (Includes 54070)</p> <p>74103-000-01</p>		<p>55</p> <p>Clip and Flange Assembly</p> <p>74414-04-01 74414-26D-01</p>
	<p>44</p> <p>Face Plate with outside knob</p> <p>74118-04-01 74118-26D-01</p>		<p>56</p> <p>Surface-mounted Cast Strike (For metal door frames; spacers included) (Not Shown on Exploded View) see page 39.</p> <p>74464-04-01 74464-26D-01</p>
	<p>45</p> <p>Center Plate and Barrel Assembly with metal buttons (100 Series) (For 9020000, 9060000, 9170000, 9350000)</p> <p>74124-04-01 74124-26D-01</p>		<p>57</p> <p>Riser Plate to shim lock housings 1/4" (6 mm) or 3/8" (10 mm) (Not Shown on Exploded View) see page 39.</p> <p>74468-04-01 74468-26D-01</p>
	<p>46</p> <p>Center Plate and Barrel Assembly with metal buttons (200 Series) (For 9040000, 9100000, 9190000, 9380000, 9290000)</p> <p>74125-04-01 74125-26D-01</p>		<p>58</p> <p>Latch holdback assembly slide button activated for NL + NLM Models</p> <p>74469-04-01 74469-26D-01</p>
	<p>47</p> <p>Key Override Cylinder (For 1 3/4" - 2 1/8" Thick Door)</p> <p>74161-04-01 74161-26D-01</p>		<p>59</p> <p>Outside Knob Assembly – Includes Hardware (Includes parts no. 34037, 54011, 54084 & 74068 of Exploded View)</p> <p>74470-04-01 74470-26D-01</p>
			<p>60</p> <p>Inside Knob Assembly – Includes hardware (Includes parts no. 34037, 54011 & 74057 of Exploded View)</p> <p>74471-04-01 74471-26D-01</p>
<p>48</p> 	<p>49</p>  <p>Gear Plate Assembly* for key bypass locks</p> <p>74162-1-000-01 (For 9350000) (NLM 100) 74163-1-000-01 (For 9380000) (NLM 200)</p>		
<p>50</p> 	<p>51</p>  <p>Gear Plate Assembly* for key bypass locks</p> <p>74164-1-000-01 (For 9060000) (DLM 100) 74167-1-000-01 (For 9100000) (DLM 200)</p>		
	<p>52</p> <p>Trigger Assembly (For NL + NLM Models)</p> <p>74290-04-01 74290-26D-01</p>		