

auta

DIGITAL

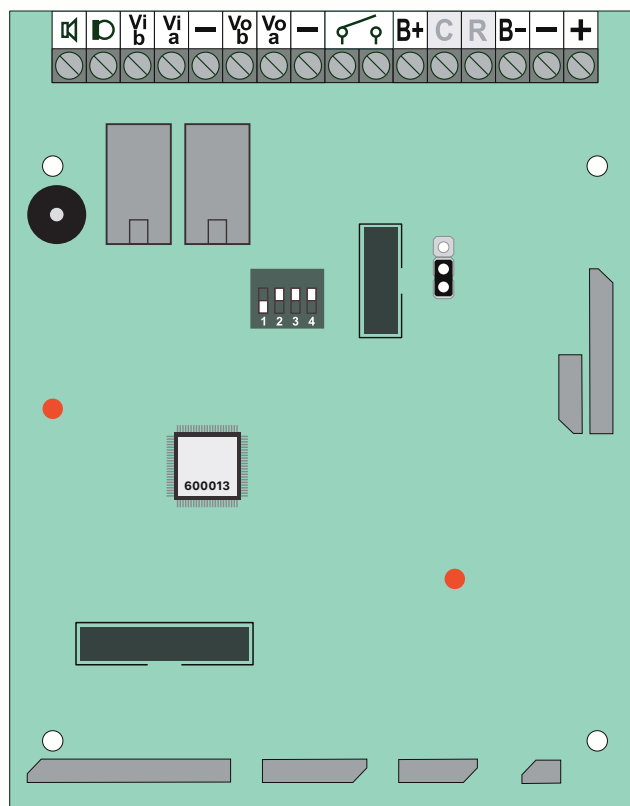

ES MÓDULO DE CONTROL 600013

EN MODULE OF CONTROL 600013

Índice

Descripción	1
Características	1
Conexión	2
Llamada a vivienda.....	3
Configuración placa de pulsadores.....	4
Configuración placa de teclado, menú AJUSTES.....	5
Configuración placa de teclado, menú BASE DE DATOS.....	6
Ejemplos de instalación, AUDIO 4H.....	7
Ejemplos de instalación, VIDEO COAX.....	8
Ejemplos de instalación, VIDEO NO-COAX.....	9
Codificación de viviendas, PLACA DE PULSADORES.....	10, 11, 12
Guía de instalación1.....	3
Nota de aplicación, CONEXIÓN PLACA DECOR.....	14

Index

Description.....	1
Features.....	1
Connection	2
Call to flat.....	3
Configuration of push-buttons panel	4
Configuration of keypad panel, SETTINGS menu	5
Configuration of keypad panel, DATABASE menu.....	6
Examples of installation, AUDIO 4W	7
Examples of installation, VIDEO COAX	8
Examples of installation, VIDEO COAXLESS.....	9
Codification of flats, PUSH-BUTTONS PANEL.....	10, 11, 12
Installation guide	13
Application note, DECOR PANEL CONNECTION	14

Descripción Description

Módulo de control para sistemas digitales Auta. Compatible con instalaciones AUDIO 4H, VIDEO COAX y VIDEO NO-COAX. Permite la gestión de placas con hasta 66 pulsadores y placas con teclado + display con hasta 65.000 usuarios. Incorpora gestión de bases de datos, tiempos de apertura, códigos de acceso, etc...

Compatible con módulos 600001, 600003, 600004, 600005, 600006, 600007, 600009 y 600012.



Module of control for Auta digital systems. Compatible with AUDIO 4W, COAX VIDEO and COAXLESS VIDEO installations. It allows the management of panels with up to 66 buttons and panels with keyboard + display with up to 65.000 users. It incorporates database management, opening times, access codes, etc ...

Compatible with modules 600001, 600003, 600004, 600005, 600006, 600007, 600009 y 600012.

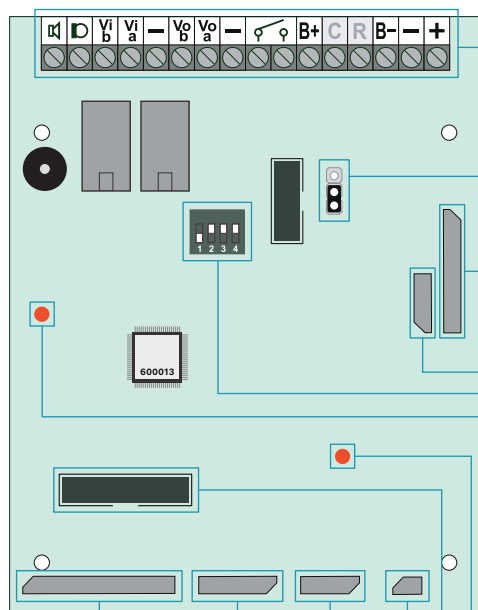
Características Features



Conexiones Connections

	Altavoz_Datos	Speaker_Data
	Micrófono	Microphone
Vi_b	Video - (entrada)	Video - (in)
Vi_a	Video + (entrada)	Video + (in)
Vo_b	Video - (salida)	Video - (out)
Vo_a	Video + (salida)	Video + (out)
	Relé libre de tensión N.A. _1A	Free tension N.O. _1A relay
B+	Pulsador apertura, borne 1	Opening button, terminal 1
C	Sin uso	Not used
R	Sin uso	Not used
B-	Pulsador apertura, borne 2	Opening button, terminal 2
-	-24 Vcc (todos iguales)	-24 Vdc (all same)
+	+24 Vcc	+24 Vdc

Selector PRINCIPAL_SECUNDARIA MAIN_SECONDARY selector



Conector AUDIO, VIDEO COAX y APERTURA (10 PINES) AUDIO, COAX VIDEO and OPENING connector (10 PINS)

Conector VIDEO NO-COAX (4 PINES) COAXLESS VIDEO connector (4 PINS)

ID de placa (binario) Panel ID (binary)



Si está ON, cortocircuito en línea datos (altavoz) If is ON, shorting in the data line (speaker)

LED de alimentación Power LED

Conector placa TECLADO KEYPAD panel connector

Conector alimentación 24Vcc (2 PINES) 24Vdc supply connector (2 PINS)

Conector para conexión a PC, se necesita interface USB Auta (4 PINES) Connector for PC connection, Auta USB interface needed (4 PINS)

Conector de COLUMNAS para placas de pulsadores (6 PINES) ROWS connector for push-buttons panels (6 PINS)

Conector de FILAS para placas de pulsadores (11 PINES) FILES connector for push-buttons panels (11 PINS)

Conexión Connection

PLACA DE PULSADORES PUSH-BUTTONS PANEL

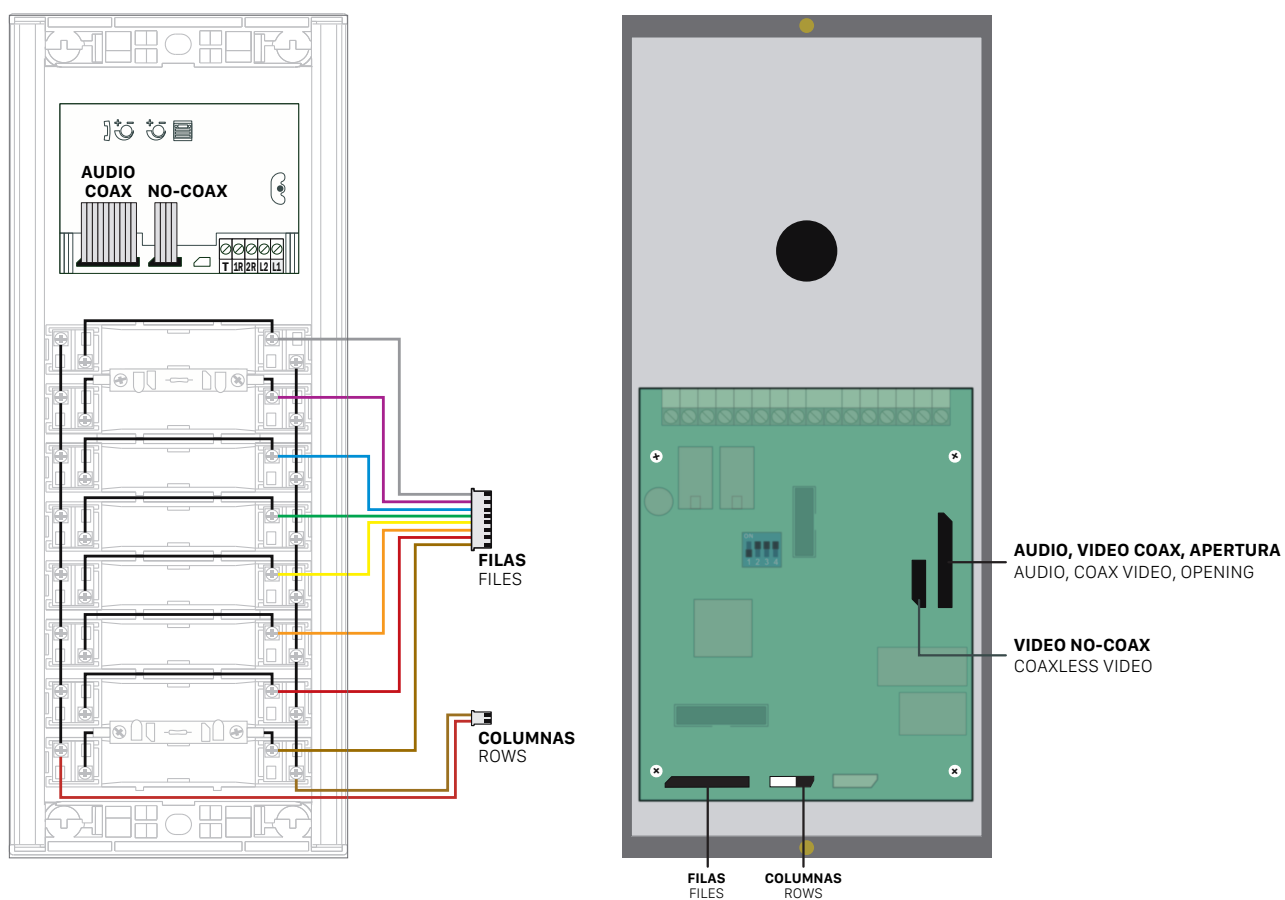

PLACA DE TECLADO KEYPAD PANEL

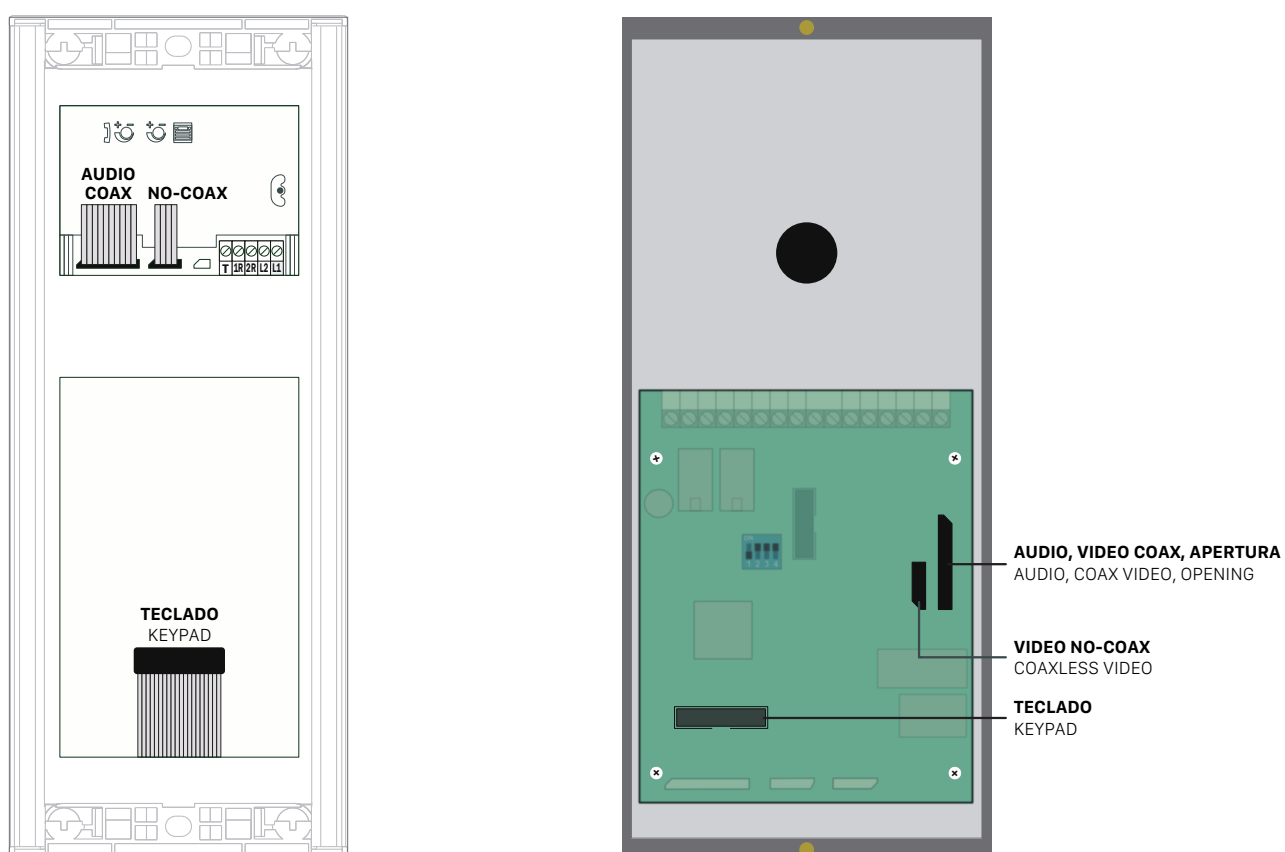

Llamada a vivienda Call to flat

► Llamada desde una placa de pulsadores Call from a push-button panel

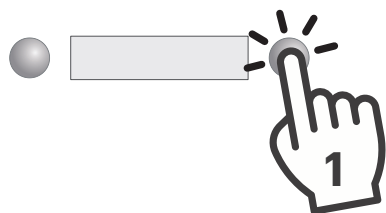

Al pulsar escucharemos un sonido corto de confirmación. Todavía NO se estará efectuando la llamada a la vivienda.

Pressing will hear a short confirmation sound.
The call to the flat will NOT be made yet.

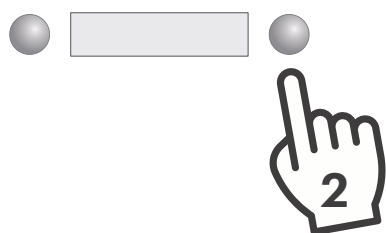

Al dejar de pulsar se efectuará la llamada a la vivienda seleccionada.

- Si escuchamos una serie de tonos cortos, el monitor_teléfono estará sonando.
- Si escuchamos un tono largo, el monitor_teléfono no estará respondiendo.

When the button is released, the call to the selected flat will be made.
- If we hear a series of short tones, the monitor_phone will be ringing.
- If we hear a long tone, the monitor_phone will not be responding.

► Llamada desde una placa de teclado Call from a keypad panel

Modo INTERIOR INTERNAL mode

◆ SIN base de datos WITHOUT database



Presionaremos el código binario de la vivienda y seguidamente CAMPANA. (desde 1 a 254).

Presionaremos C para rectificar o cancelar una llamada en curso.

We will press the binary code of the flat and then BELL (from 1 to 254).
We will press C to rectify or cancel an ongoing call.

◆ CON base de datos WITH database



Presionaremos el código binario de la vivienda y seguidamente CAMPANA. (podremos usar hasta 9 dígitos de llamada).

Presionaremos C para rectificar o cancelar una llamada en curso.

We will press the binary code of the flat and then BELL (we be able to use up to 9 digits to call).

We will press C to rectify or cancel an ongoing call.

Modo EXTERIOR EXTERNAL mode

◆ SIN base de datos WITHOUT database



Efectuaremos la llamada siguiendo el siguiente patrón:

1º Código binario de SDL + CAMPANA (desde 1 a 254)

2º Código binario de vivienda + CAMPANA (desde 1 a 254)

Presionaremos C para rectificar o cancelar una llamada en curso.

We will do the call following the next pattern:

1º Binary code of SDL + BELL (from 1 to 254)

2º Binary code of flat + BELL (from 1 to 254)

We will press C to rectify or cancel an ongoing call.

◆ CON base de datos WITH database



Presionaremos el código binario de la vivienda y seguidamente CAMPANA. (podremos usar hasta 9 dígitos de llamada).

Presionaremos C para rectificar o cancelar una llamada en curso.

We will press the binary code of the flat and then BELL (we be able to use up to 9 digits to call).

We will press C to rectify or cancel an ongoing call.

Configuración Configuration

Ajustes predefinidos desde fábrica. Algunos de ellos pueden ser modificados de forma directa y otros necesitan ser modificados conectando una placa teclado o un teclado MINI (730165).

Factory default settings. Some of them can be modified directly and others need to be modified by connecting a keyboard panel or a MINI keyboard (730165).

	Función Function	Fábrica Factory	Modificación directa Direct modification
AUTO	Auto-encendido Self-starting	✓	✓
CCI	Llamada a conserjería Call to switchboard	✗	✓
P66	Pulsador 66 llama a conserje Push-button 66 calls to concierge	✗	✓
67_132	Códigos de pulsador desde 66 a 132 Push-buttons codes from 67 to 132	✗	✓
TIEMPO APERT. 1 OPENING TIME 1	Tiempo de apertura desde vivienda Opening time from flat	2 segundos 2 seconds	✗
TIEMPO APERT. 2 OPENING TIME 2	Tiempo de apertura desde pulsador B+ Opening time from push-button B+	5 segundos 5 seconds	✗
MODO MODE	Modo de funcionamiento Functioning mode	INTERIOR INTERNAL	✗

PLACA DE PULSADORES PUSH-BUTTON PANEL

Para modificar algunos de los ajustes superiores, sin necesidad de conectar un teclado+display, deberemos realizar el siguiente procedimiento.

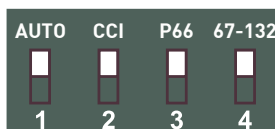

To modify any of the settings above, without connecting a keypad+display, we'll follow the next steps.



- 1. Anotar la configuración del módulo de control**
Annotate the configuration of the module of control
- 2. Desconectar el positivo del módulo de control**
Disconnect positive of the module of control
- 3. Realizar un puente, con un trozo de cable, entre B+ y B-**
Do a bridge, with a piece of wire, between B+ and B-
- 4. Colocar hacia abajo las funciones que deseamos activar y dejar arriba las que deseamos que permanezcan desactivadas**
Set down the functions we want to activate and leave up the functions we want to leave disabled
- 5. Conectar el positivo del módulo de control. El módulo comenzará a emitir pitidos**
Connect positive of the module of control. The module will start to emit beeps
- 6. Validar las funciones seleccionadas pulsando el pulsador 1 (Fila 1 - Columna 1)**
Validate the selected functions by pressing the push-button 1 (File 1 - Row 1)
- 7. El modulo de control dejará de pitar**
The module of control will stops emitting beeps
- 8. Desconectar el positivo del módulo de control y deshacer el puente realizado en el paso 3**
Disconnect the positive of the module of control and undo the bridge done in the step 3
- 9. Configurar de nuevo el código anotado en el paso 1**
Set again the code annotated in the step 1
- 10. Conectar el positivo del módulo de control**
Connect positive of the module of control

PLACA DE TECLADO ó TECLADO MINI (730165) KEYPAD PANEL or MINI KEYPAD (730165)

 ▶ **Menu, Ajustes** Menu, Settings

-  **Siguiente menú**
Next menu
-  **Validar_Cambiar**
Validate_Change

IDIOMA - LANGUAGE
CASTELLANO
Selección de idioma CASTELLANO_INGLÉS
 Language SPANISH_ENGLISH

CODIGO APERT. 1
101010
Código de apertura 1 (101010) (0, desactivado)
Código de apertura 2 (202020) (0, desactivado)
Código de apertura 3 (303030) (0, desactivado)
Código de apertura 4 (404040) (0, desactivado)
Como activar apertura

 Opening code 1 (101010) (0, disabled)
 Opening code 2 (202020) (0, disabled)
 Opening code 3 (303030) (0, disabled)
 Opening code 4 (404040) (0, disabled)

How to activate the opening

TIEMPO APERT. 1
2 seg
Tiempo de apertura 1 (2 seg) (apertura desde vivienda)
Tiempo de apertura 2 (5 seg) (apertura desde pulsador B+ y B-)

 Opening time 1 (2 sec) (opening from flat)
 Opening time 2 (5 sec) (opening from push-button B+ y B-)

NUMERO DE PLACA
1
Información del código de placa configurado en el switch binario
 Panel code information configured on the binary switch

PLACA: interior
V4.0-180723
PLACA: interior (configurada para llamar a viviendas)
PLACA: exterior (configurada para llamar a SDL)
Versión de software del módulo de control

 PANEL: internal (set to call flats)
 PANEL: external (set to call SDL)
 Software version of the module of control

AUTOENCENDIDO si
La placa permite el auto-encendido desde viviendas, defecto SI
 The panel allows the self-starting from flats, default YES



CONSERJERIA no
La placa puede realizar llamadas a central de conserjería, defecto NO
 The panel can do calls to a switchboard, default NO

NUEVO COD ACCESO CONFIG:
1
NUEVO COD ACCESO CONFIG: 1 **cambia el código de acceso al menú configuración**
NUEVO COD ACCESO DIRECT: 9 **cambia el código de acceso al menú de gestión de bases de datos**

NEW ACCESS CODE CONFIG: 1 changes the access code for the configuration menu

NEW ACCESS CODE CONFIG: 9 changes the access code for the database management menu

▶ **Menu, base de datos de viviendas (opcional)** Menu, database of flats (optional)

-  **Atrás_Salir**
Back_Exit
-  **Validar_Cambiar**
Validate_Change

ADD: 1 BORRA: 2
MUESTRA/CAMBIA: 3

1

Manual: 4 Auto: 5
Remoto: 6 Otros: 7

4

m/t: 1 SDL: 1
llamada: 1



m/t: 1 SDL: 1
cod apert: 000000

m/t (código binario del monitor/teléfono)
SDL (código binario del SDL) *
llamada (código que se desea usar para llamar, hasta 9 dígitos)
cod apert. (sin uso)

m/t (binary code of the monitor/phone)
SDL (binary code of the SDL) *
call (code we want to use for to call, up to 9 digits)
opening code (not used)

* **Campo disponible si la placa está configurada como EXTERIOR**

* Field available if the panel is set as EXTERNAL

5

Borrar TODO?

Borra la base de datos completa
Erases the full database

6

Recepción...

Esperando recibir base de datos desde PC (interface USB Auta)
Waits to receive a database from PC (Auta USB interface)

7

1 - 254: 8 P→PC: 9

1 - 254 (crea una base de datos con 254 registros)
P→PC (transmite la base de datos a un PC) (interface USB Auta)
1 - 254 (creates a database of 254 registers)
P→PC (transmits the database to a PC) (Auta USB interface)

2

m/t: 1 SDL: 1
llamada: 1

Borrar el registro que aparece en pantalla
Deletes the register that appears in the display



Avanza
Next



Borra
Delete

* Para salir presionar cualquier número
* To exit press any number

3

m/t: 1 SDL: 1
llamada: 1

Permite navegar y modificar cualquier registro
Allows to navigate and modify any register



Avanza
Next



Cambiar
Change

* Para salir, estando en el campo
"Cod. Apert." presionar "C"
* To exit, once you are in the field
"Opening code" press "C"

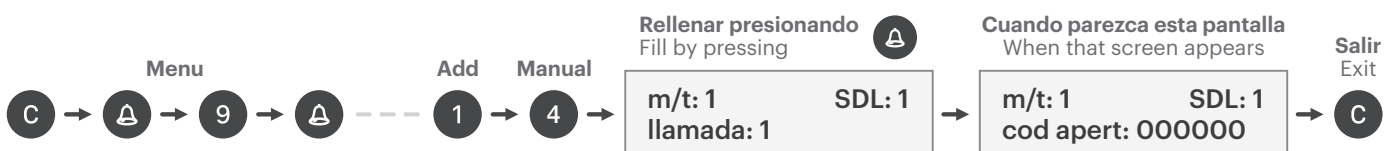
 ■ **Ejemplo de como crear un registro manualmente** Example of how to create a register manually

Ejemplos de instalación Installation examples

SISTEMA, AUDIO 4H SYSTEM, AUDIO 4W

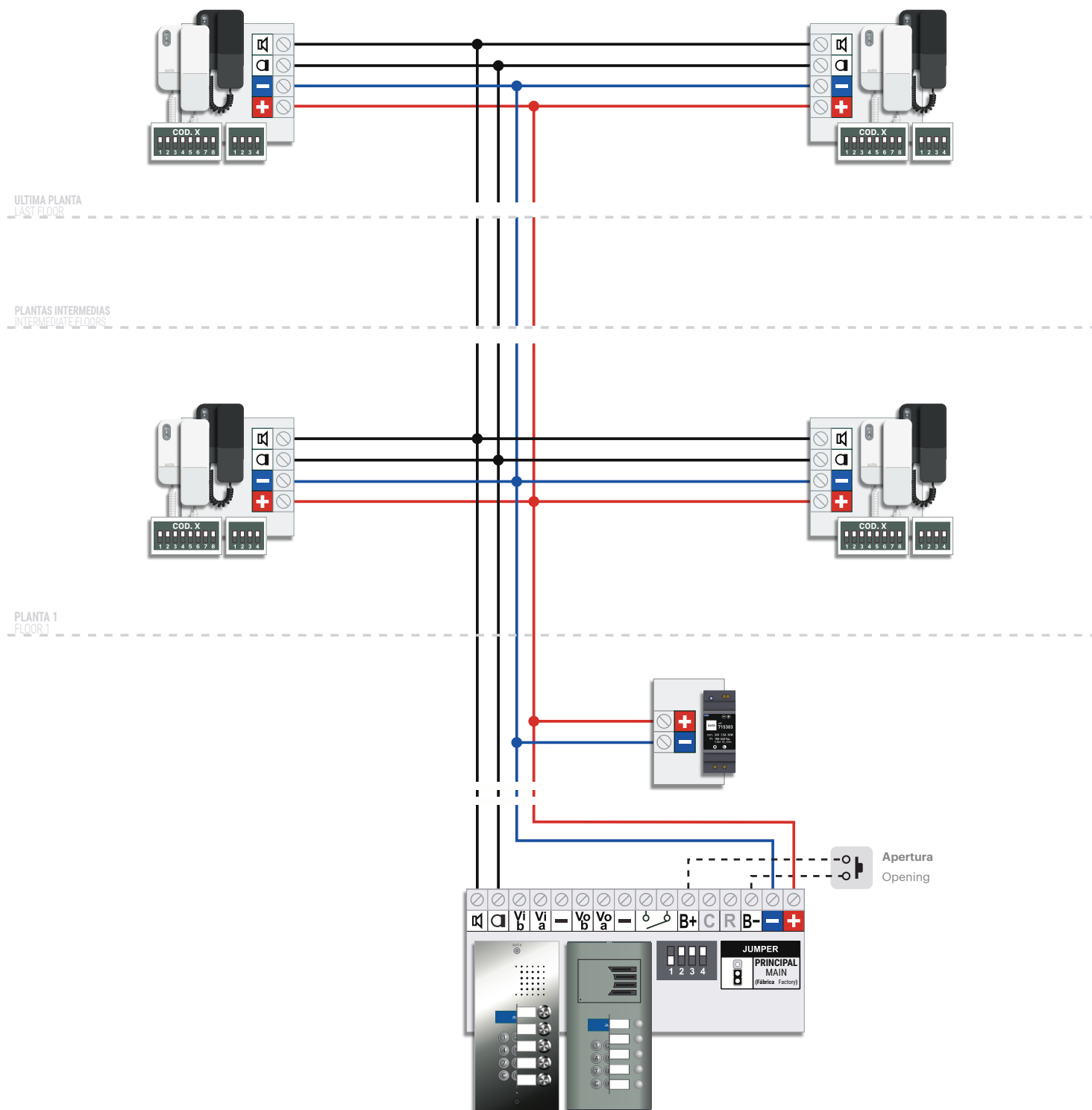

Manual de instalación AUDIO 4H
 Installation manual AUDIO 4W

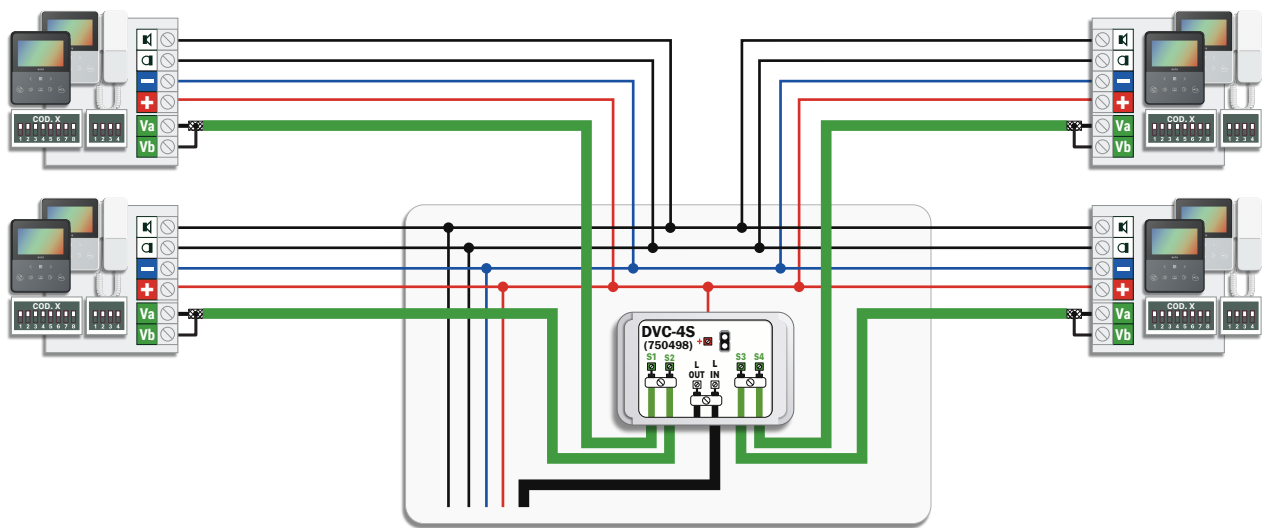
SISTEMA, COAX SYSTEM, COAX

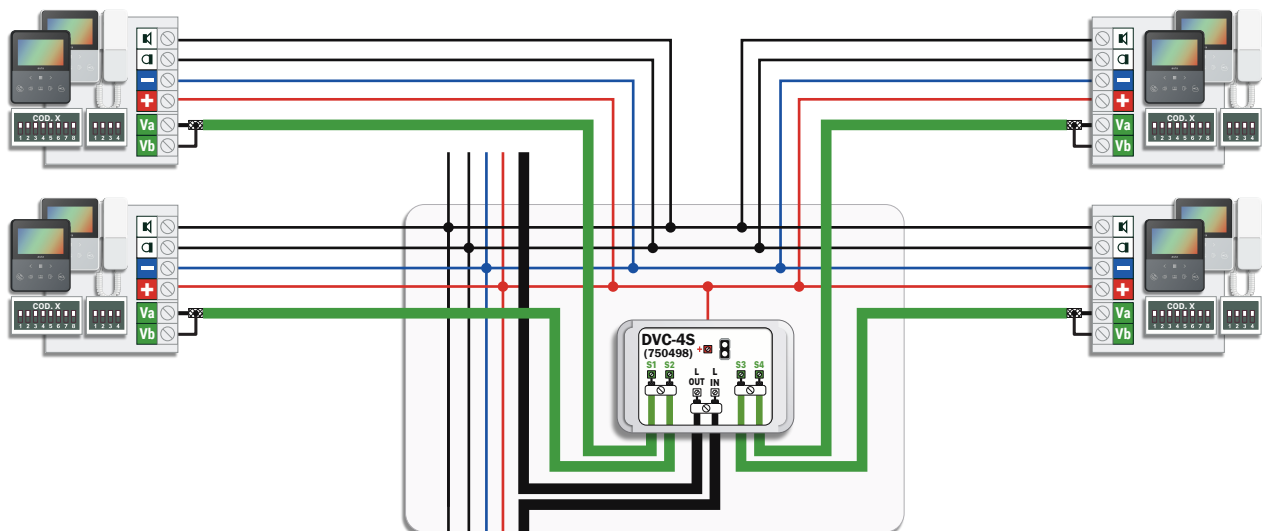
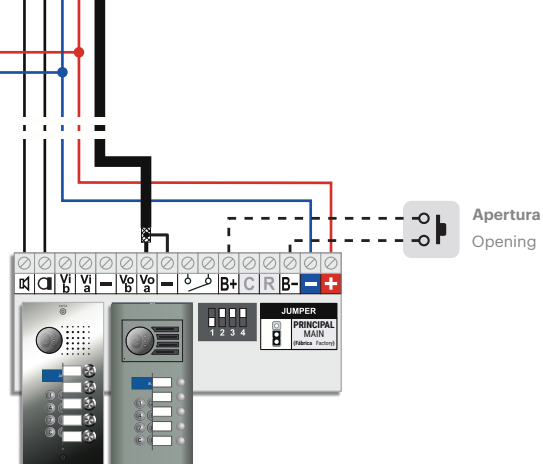
 ULTIMA PLANTA
 LAST FLOOR

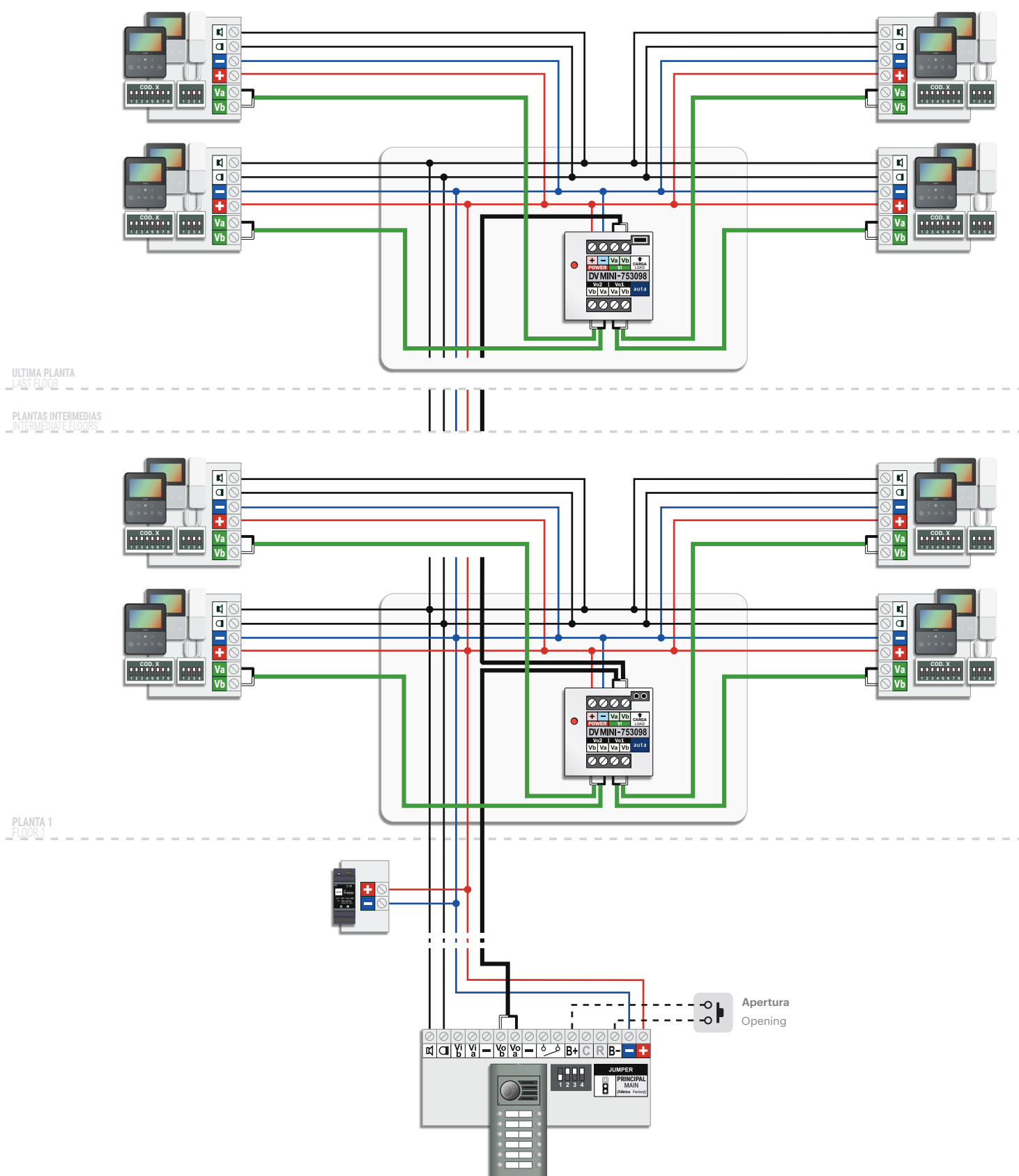
 PLANTAS INTERMEDIAS
 INTERMEDIATE FLOORS

 PLANTA 1
 FLOOR 1

Manual de instalación VIDEO COAX
 Installation manual VIDEO COAX

SISTEMA, NO-COAX SYSTEM, COAXLESS

Manual de instalación VIDEO NO-COAX
 Installation manual VIDEO COAXLESS

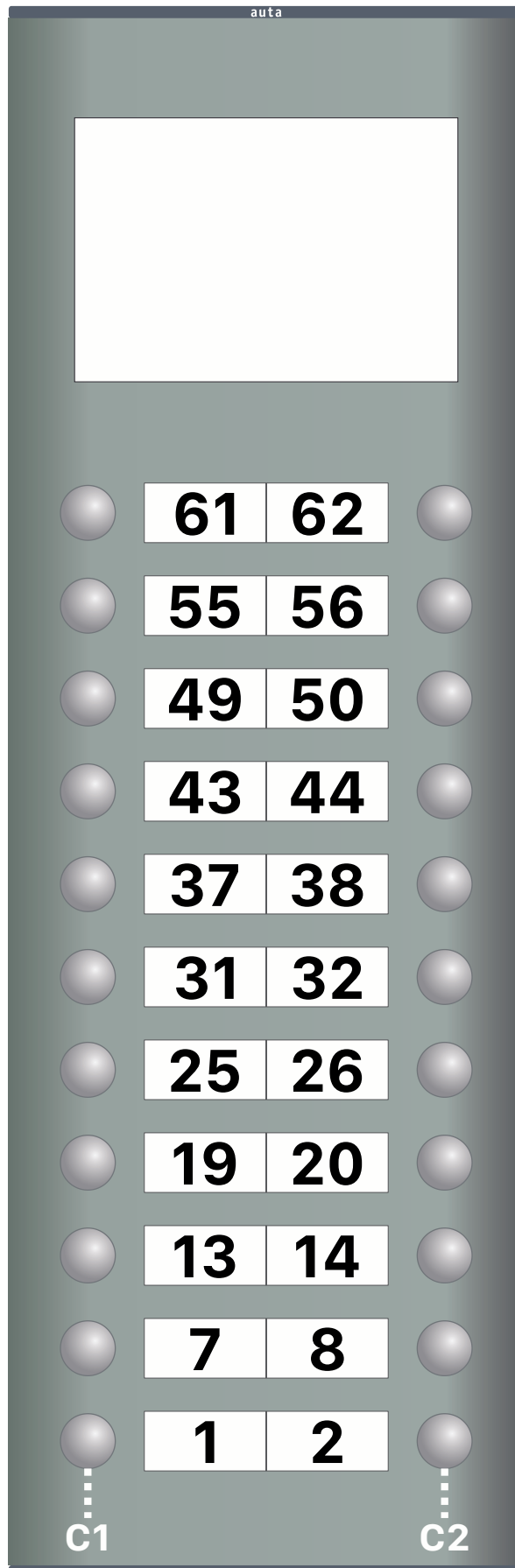
Codificación de viviendas, PULSADORES Flats codification, PUSH-BUTTONS

CÓDIGOS QUE GENERA CADA PULSADOR CODES THAT GENERATES EVERY PUSH-BUTTON



SELECCIÓN DE PULSADORES PUSH-BUTTONS SELECTION

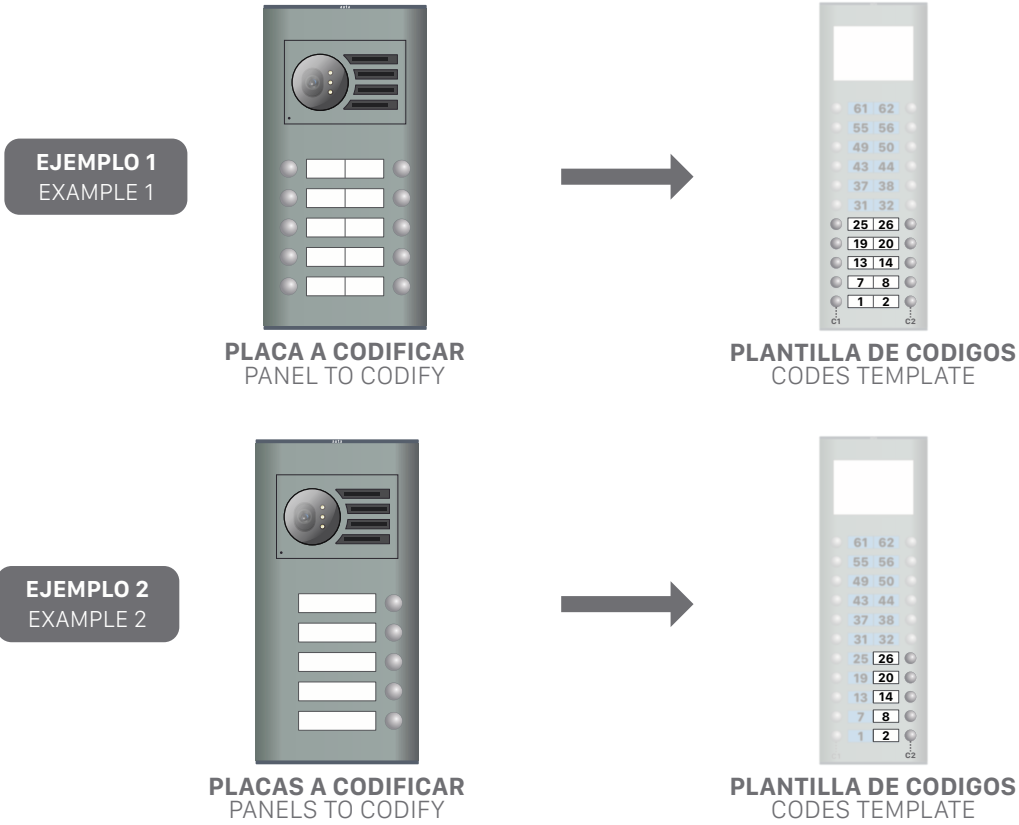

CONVERSIÓN DE CÓDIGOS A BINARIO BINARY CODES CONVERSION

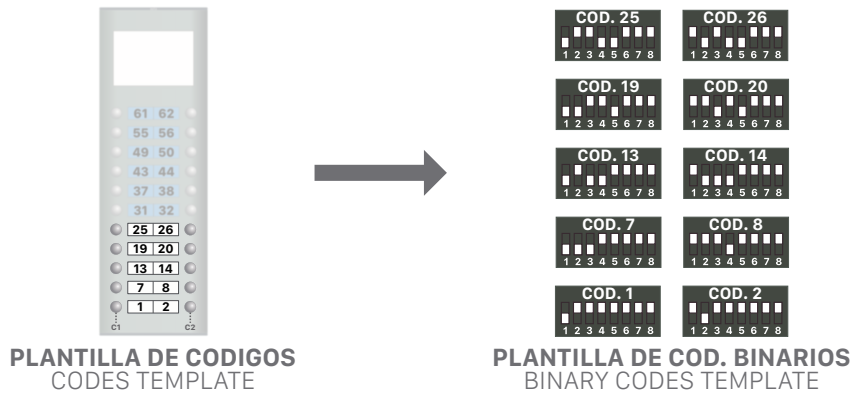

CODIFICACIÓN DE LOS ELEMENTOS CODIFICATION OF DEVICES

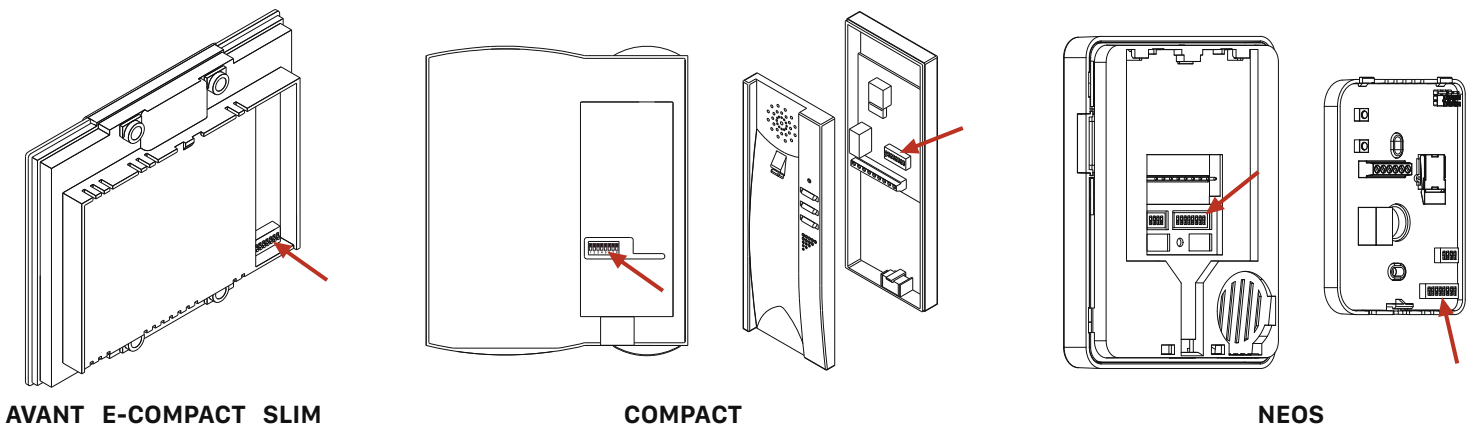







Guía de instalación Installation guide

SECCIONES RECOMENDADAS RECOMMENDED SECTIONS

► Sistema, AUDIO 4H System, AUDIO 4W

SECCIONES WIRING SECTIONS	HASTA 100m UP TO 100m	HASTA 200m UP TO 200m
+ -	1mm AWG17	1.5mm AWG15
	0.5mm AWG20	1mm AWG17
EL CABLEADO NO DEBE PASAR CERCA DE LA LINEA ELÉCTRICA WIRING MUST NOT BE RUN CLOSE TO THE ELECTRICAL LINE		









CAT 5/6/FTP	AUTA
	+
	-
	
	
100% COBRE 100% COPPER	





► Sistema, COAX System, COAX

SECCIONES WIRING SECTIONS	HASTA 100m UP TO 100m	HASTA 200m UP TO 200m
+ -	1mm AWG17	1.5mm AWG15
	0.5mm AWG20	1mm AWG17
COAXIAL	RG-59 75Ω	
EL CABLEADO NO DEBE PASAR CERCA DE LA LINEA ELÉCTRICA WIRING MUST NOT BE RUN CLOSE TO THE ELECTRICAL LINE		

► Sistema, NO-COAX System, COAXLESS

SECCIONES WIRING SECTIONS	HASTA 100m UP TO 100m	HASTA 200m UP TO 200m
+ -	1mm AWG17	1.5mm AWG15
	0.5mm AWG20	1mm AWG17
Va Vb	2 x 0.22mm AWG22	
EL CABLEADO NO DEBE PASAR CERCA DE LA LINEA ELÉCTRICA WIRING MUST NOT BE RUN CLOSE TO THE ELECTRICAL LINE		

CAT 5/6/FTP	AUTA
	+
	-
	Va
	Vb
	
	
100% COBRE 100% COPPER	

NO DUPLICAR CABLES Va Vb DON'T DUPLICATE WIRES Va Vb	
	
	

CONEXIÓN DE ABREPUERTAS DOOR LOCK CONNECTION

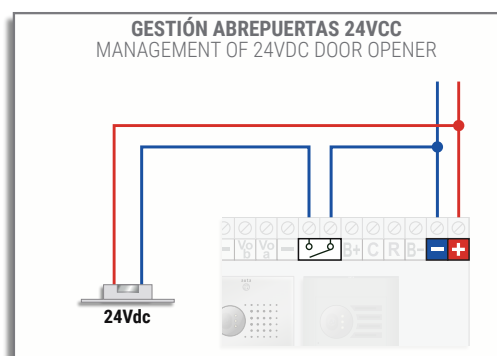
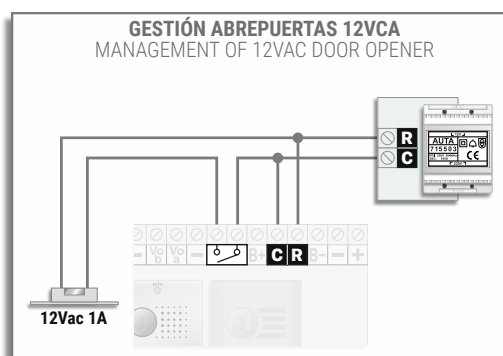

CONEXIÓN CON PLACA DECOR CONNECTION WITH DECOR PANEL

